

ORES COUPLING

7:7



7:7



HYDROSCAND ORFS-COUPLING

PRODUCT GROUP 770/510

- * Our ORFS couplings are equivalent to SAE J1453 and ISO 8434-3.
- * The couplings handle high pressure up to 63.0 MPa, with a safety factor of 1:4. They are also resistant to vibrations and system impulses.
- * The sealing between pipe and adaptor is created by a O-ring, which gives a safe unit.
- * The coupling can be dismantled and assembled multiple times without deterioration of the unit. The only thing that needs to be changed is the O-ring.
- * Compared to other types of steel pipe couplings, the ORFS coupling is very resistant to over-torque. This makes a correct assembling easier, even for untrained persons.
- * By changing the clamping sleeve, the coupling can be used for both metric and inch pipes.

Part numbers

The ORFS coupling part number consists of two parts.

The first four digits signify the type (compare with the flare fittings).

The four last digits signify the recommended pipe size in inches. 1/4" for example, gives part number 04.

For deviating connections, the thread size is given in the part number, for example G 3/8" = 06.

Pipe OD		Thread	Part number
mm	inch	UN	
6	1/4"	9/16"-18 UNF	04
8	5/16"	11/16"-16 UN	06
10	3/8"	11/16"-16 UN	06
12	1/2"	13/16"-16 UN	08
14			10
15			10
16	5/8"	1"-14 UNS	10
18	3/4"	1 3/16"-12 UN	12
20			12
22	7/8"	1 7/16"-12 UN	16
25	1"	1 7/16"-12 UN	16
28			20
30			20
32	1 1/4"	1 11/16"-12 UN	20
35			24
38	1 1/2"	2"-12 UN	24

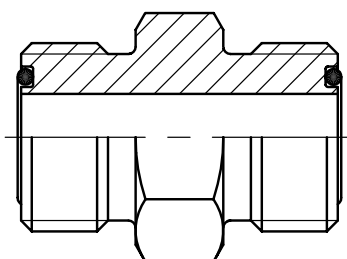

TABLE OF CONTENTS



ORFS COUPLINGS

PAGE

7701	Straight coupling	348
7702	Elbow coupling 90°	348
7703	T-coupling	348
7705	Bulkhead	348
7705-00	Lock nut	348
7706	Elbow coupling 90° bulkhead	348
7707	Elbow coupling 45° bulkhead	348
7709	T-coupling - ORFS x ORFS x ORFS bulkhead	349
7710	L-coupling - ORFS x ORFS x ORFS bulkhead.	349
7711	Straight coupling, NPT thread	349
7713	Straight coupling, G thread	349
7714	Straight coupling, UNF thread, SAE O	350
7715	Straight coupling, M thread	350
7716	Straight coupling, G thread with ED-seal	350
7717	Straight coupling, ORFS thread	350
7718	Straight coupling, M thread with ED-seal	351
7720	Elbow coupling 90°, NPT thread	351
7722	Adjustable elbow coupling 90°, G thread	351
7723	Adjustable elbow coupling 90°, UNF thread	351
7724	Adjustable elbow coupling 90°, M thread	352
7725	Long adjustable elbow coupling 90°, UNF	352
7730	Elbow coupling 45°, NPT thread	352
7732	Adjustable elbow coupling 45°, G thread	352
7733	Adjustable elbow coupling 45°, UNF thread	352
7740	T-coupling, NPT thread	352
7741	T-coupling - ORFS x ORFS x G thread	353
7742	T-coupling - ORFS x ORFS x UNF thread	353
7744	L-coupling - ORFS x ORFS x G thread	353
7745	L-coupling - ORFS x ORFS x UNF thread	353
7758	Straight coupling - swivel nut	353
7759	Straight coupling - swivel nut	353
7760	90° elbow coupling - swivel nut	353
7761	45° elbow coupling - swivel nut	354
7762	T-coupling - swivel nut	354
7763	L-coupling - swivel nut	354
7765	Adaptor, G thread with ED-seal - swivel nut	354
7766	Adaptor, G thread - swivel nut	354
7767	Adaptor with ORFS swivel nut	354
7768	Adaptor, MM thread with ED-seal - swivel nut	355
7770	Reduction	355
7771	Straight bulkhead, G thread	355
7772	Straight bulkhead, UNF thread, SAE O	355
7773	Straight bulkhead, NPT thread	355
7780	Manometer coupling, G thread	355
7781	Test point	355
7790	Cap	355
7791	Plug	356
7792	Nut	356
7793	Clamping sleeve	356
5610-07	O-ring	356
7794	Braze sleeve	356





ASSEMBLY INSTRUCTIONS ORFS

1. Lubrication

Lubricate the O-ring before assembly.

On couplings in steel, the threads do not need lubrication. On couplings in stainless steel, the threads should be lubricated to not cut. Use recommended lubricant part.no 5650-00-05.

2. Assembly

Screw the nut on the body.

Tighten the nut until metal contact is obtained.

Mark on body and nut.

Then tighten the nut according to the table below.

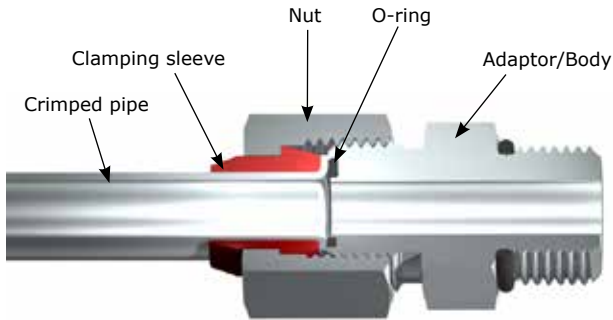

Flanging

Cut the pipe so the flange is 90°. The clamping sleeve in combination with the nut and O-ring seal the unit.

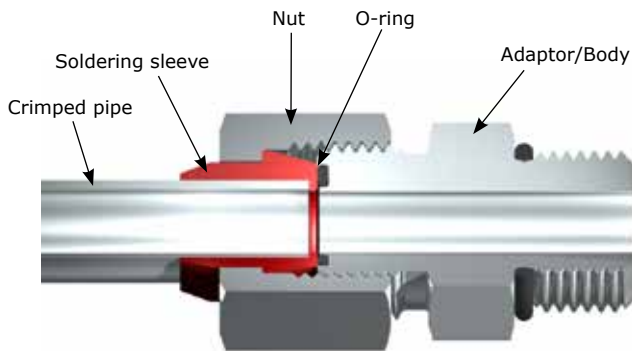

Brazing

An alternative to cut the pipe is to braze/weld an ORFS sleeve to the pipe.

Tightening torque

Pipe (mm)	Pipe dim.	Thread	FFWR new	FFWR reassembly
6	1/4"	9/16"-18 UNF	1/2-3/4	1/4-1/2
8	5/16"	11/16"-16 UN	1/2-3/4	1/4-1/2
10	3/8"	11/16"-16 UN	1/2-3/4	1/4-1/2
12	1/2"	13/16"-16 UN	1/2-3/4	1/4-1/2
14		1"-14 UNS	1/2-3/4	1/4-1/2
15		1"-14 UNS	1/2-3/4	1/4-1/2
16	5/8"	1"-14 UNS	1/2-3/4	1/4-1/2
18		1.3/16"-12 UN	1/3-1/2	1/4-1/2
20	3/4"	1.3/16"-12 UN	1/3-1/2	1/4-1/2
22	7/8"	1.7/16"-12 UN	1/3-1/2	1/4-1/2
25	1"	1.7/16"-12 UN	1/3-1/2	1/4-1/2
28		1.11/16"-12 UN	1/3-1/2	1/4-1/2
30		1.11/16"-12 UN	1/3-1/2	1/4-1/2
32	1.1/4"	1.11/16"-12 UN	1/3-1/2	1/4-1/2
38	1.1/2"	2"-12 UN	1/3-1/2	1/4-1/2

FFWR Flats From Wrench Resistance

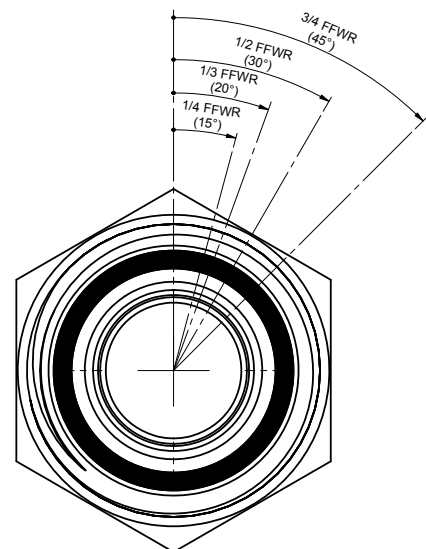



7701
ORFS
Steel

PRODUCT GROUP 770

Part number	Thread 1	Thread 2
7701-04-04	ORFS 04	ORFS 04
7701-04-06	ORFS 04	ORFS 06
7701-06-06	ORFS 06	ORFS 06
7701-06-08	ORFS 06	ORFS 08
7701-08-08	ORFS 08	ORFS 08
7701-08-10	ORFS 08	ORFS 10
7701-08-12	ORFS 08	ORFS 12
7701-10-10	ORFS 10	ORFS 10
7701-10-12	ORFS 10	ORFS 12
7701-12-12	ORFS 12	ORFS 12
7701-12-16	ORFS 12	ORFS 16
7701-16-16	ORFS 16	ORFS 16
7701-16-20	ORFS 16	ORFS 20
7701-20-20	ORFS 20	ORFS 20
7701-20-24	ORFS 20	ORFS 24
7701-24-24	ORFS 24	ORFS 24

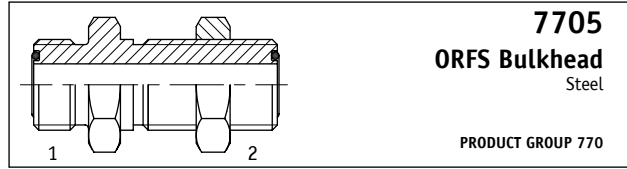

7705
ORFS Bulkhead
Steel

PRODUCT GROUP 770

Part number	Thread 1	Thread 2
7705-04-04	ORFS 04	ORFS 04 Bulkhead
7705-06-04	ORFS 06	ORFS 04 Bulkhead
7705-06-06	ORFS 06	ORFS 06 Bulkhead
7705-08-08	ORFS 08	ORFS 08 Bulkhead
7705-10-10	ORFS 10	ORFS 10 Bulkhead
7705-12-12	ORFS 12	ORFS 12 Bulkhead
7705-16-16	ORFS 16	ORFS 16 Bulkhead
7705-20-20	ORFS 20	ORFS 20 Bulkhead
7705-24-24	ORFS 24	ORFS 24 Bulkhead



7702
ORFS 90°
Steel

PRODUCT GROUP 770

Part number	Thread 1	Type	Thread 2
7702-04-04	ORFS 04	90°	ORFS 04
7702-06-06	ORFS 06	90°	ORFS 06
7702-08-08	ORFS 08	90°	ORFS 08
7702-10-10	ORFS 10	90°	ORFS 10
7702-12-12	ORFS 12	90°	ORFS 12
7702-16-16	ORFS 16	90°	ORFS 16
7702-20-20	ORFS 20	90°	ORFS 20
7702-24-24	ORFS 24	90°	ORFS 24

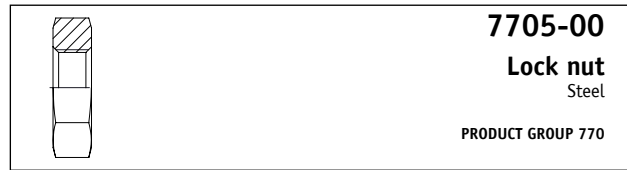

7705-00
Lock nut
Steel

PRODUCT GROUP 770

Part number	Type	Thread
7705-00-04	Lock nut	ORFS 04
7705-00-06	Lock nut	ORFS 06
7705-00-08	Lock nut	ORFS 08
7705-00-10	Lock nut	ORFS 10
7705-00-12	Lock nut	ORFS 12
7705-00-16	Lock nut	ORFS 16
7705-00-20	Lock nut	ORFS 20
7705-00-24	Lock nut	ORFS 24

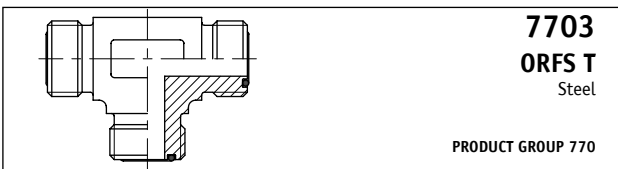

7703
ORFS T
Steel

PRODUCT GROUP 770

Part number	Thread 1	Thread 2	Thread 3	Type
7703-04-04	ORFS 04	ORFS 04	ORFS 04	T
7703-06-06	ORFS 06	ORFS 06	ORFS 06	T
7703-08-08	ORFS 08	ORFS 08	ORFS 08	T
7703-10-10	ORFS 10	ORFS 10	ORFS 10	T
7703-12-12	ORFS 12	ORFS 12	ORFS 12	T
7703-16-16	ORFS 16	ORFS 16	ORFS 16	T
7703-20-20	ORFS 20	ORFS 20	ORFS 20	T
7703-24-24	ORFS 24	ORFS 24	ORFS 24	T

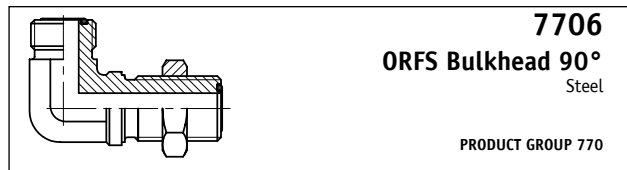

7706
ORFS Bulkhead 90°
Steel

PRODUCT GROUP 770

Part number	Thread 1	Type	Thread 2
7706-04-04	ORFS 04	90°	ORFS 04 Bulkhead
7706-06-06	ORFS 06	90°	ORFS 06 Bulkhead
7706-08-08	ORFS 08	90°	ORFS 08 Bulkhead
7706-10-10	ORFS 10	90°	ORFS 10 Bulkhead
7706-12-12	ORFS 12	90°	ORFS 12 Bulkhead
7706-16-16	ORFS 16	90°	ORFS 16 Bulkhead
7706-20-20	ORFS 20	90°	ORFS 20 Bulkhead
7706-24-24	ORFS 24	90°	ORFS 24 Bulkhead

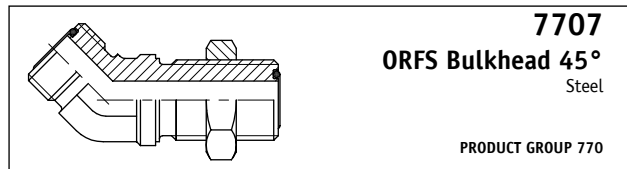

7707
ORFS Bulkhead 45°
Steel

PRODUCT GROUP 770

Part number	Thread 1	Type	Thread 2
7707-04-04	ORFS 04	45°	ORFS 04 Bulkhead
7707-06-06	ORFS 06	45°	ORFS 06 Bulkhead
7707-08-08	ORFS 08	45°	ORFS 08 Bulkhead
7707-10-10	ORFS 10	45°	ORFS 10 Bulkhead
7707-12-12	ORFS 12	45°	ORFS 12 Bulkhead
7707-16-16	ORFS 16	45°	ORFS 16 Bulkhead
7707-20-20	ORFS 20	45°	ORFS 20 Bulkhead
7707-24-24	ORFS 24	45°	ORFS 24 Bulkhead





7709
ORFS Bulkhead T
Steel

PRODUCT GROUP 770

Part number	Thread 1	Thread 2	Thread 3	Type
7709-06-06	ORFS 06	ORFS 06	ORFS 06	T Bulkhead
7709-08-08	ORFS 08	ORFS 08	ORFS 08	T Bulkhead
7709-10-10	ORFS 10	ORFS 10	ORFS 10	T Bulkhead
7709-12-12	ORFS 12	ORFS 12	ORFS 12	T Bulkhead

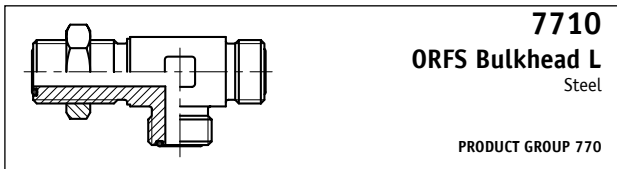

7710
ORFS Bulkhead L
Steel

PRODUCT GROUP 770

Part number	Thread 1	Thread 2	Thread 3	Type
7710-04-04	ORFS 04	ORFS 04	ORFS 04	L Bulkhead
7710-06-06	ORFS 06	ORFS 06	ORFS 06	L Bulkhead
7710-08-08	ORFS 08	ORFS 08	ORFS 08	L Bulkhead
7710-10-10	ORFS 10	ORFS 10	ORFS 10	L Bulkhead
7710-12-12	ORFS 12	ORFS 12	ORFS 12	L Bulkhead
7710-16-16	ORFS 16	ORFS 16	ORFS 16	L Bulkhead

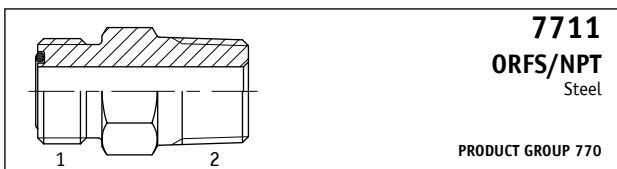

7711
ORFS/NPT
Steel

PRODUCT GROUP 770

Part number	Thread 1	Thread 2
7711-04-02	ORFS 04	1/8"-27 NPT
7711-04-04	ORFS 04	1/4"-18 NPT
7711-04-06	ORFS 04	3/8"-18 NPT
7711-04-08	ORFS 04	1/2"-14 NPT
7711-06-02	ORFS 06	1/8"-27 NPT
7711-06-04	ORFS 06	1/4"-18 NPT
7711-06-06	ORFS 06	3/8"-18 NPT
7711-06-08	ORFS 06	1/2"-14 NPT
7711-08-04	ORFS 08	1/4"-18 NPT
7711-08-06	ORFS 08	3/8"-18 NPT
7711-08-08	ORFS 08	1/2"-14 NPT
7711-08-12	ORFS 08	3/4"-14 NPT
7711-10-08	ORFS 10	1/2"-14 NPT
7711-10-12	ORFS 10	3/4"-14 NPT
7711-12-08	ORFS 12	1/2"-14 NPT
7711-12-12	ORFS 12	3/4"-14 NPT
7711-12-16	ORFS 12	1"-11½ NPT
7711-16-12	ORFS 16	3/4"-14 NPT
7711-16-16	ORFS 16	1"-11½ NPT
7711-16-20	ORFS 16	1 1/4"-11½ NPT
7711-20-16	ORFS 20	1"-11½ NPT
7711-20-20	ORFS 20	1 1/4"-11½ NPT
7711-20-32	ORFS 20	2"-11½ NPT
7711-24-24	ORFS 24	1 1/2"- 11½ NPT

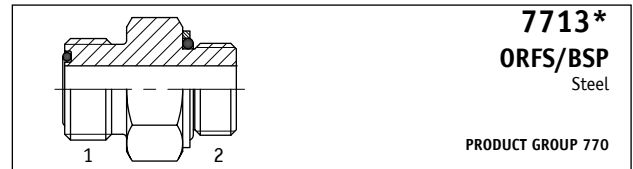

7713*
ORFS/BSP
Steel

PRODUCT GROUP 770

Part number	Thread 1	Thread 2
7713-04-02	ORFS 04	G 1/8"
7713-04-04	ORFS 04	G 1/4"
7713-04-06	ORFS 04	G 3/8"
7713-04-08	ORFS 04	G 1/2"
7713-06-04	ORFS 06	G 1/4"
7713-06-06	ORFS 06	G 3/8"
7713-06-08	ORFS 06	G 1/2"
7713-06-12	ORFS 06	G 3/4"
7713-08-04	ORFS 08	G 1/4"
7713-08-06	ORFS 08	G 3/8"
7713-08-08	ORFS 08	G 1/2"
7713-08-12	ORFS 08	G 3/4"
7713-08-16	ORFS 08	G 1"
7713-10-06	ORFS 10	G 3/8"
7713-10-08	ORFS 10	G 1/2"
7713-10-10	ORFS 10	G 5/8"
7713-10-12	ORFS 10	G 3/4"
7713-12-08	ORFS 12	G 1/2"
7713-12-12	ORFS 12	G 3/4"
7713-12-16	ORFS 12	G 1"
7713-12-20	ORFS 12	G 1 1/4"
7713-16-12	ORFS 16	G 3/4"
7713-16-16	ORFS 16	G 1"
7713-16-20	ORFS 16	G 1 1/4"
7713-20-16	ORFS 20	G 1"
7713-20-20	ORFS 20	G 1 1/4"
7713-20-24	ORFS 20	G 1 1/2"
7713-24-20	ORFS 24	G 1 1/4"
7713-24-24	ORFS 24	G 1 1/2"

*Available in a improved version with ED sealing, see 7716



7714
ORFS/UNF
Steel

PRODUCT GROUP 770



7716
ORFS/BSP - ED
Steel

PRODUKTGRUPP 770

Part number	Thread 1	Thread 2
7714-04-07	ORFS 04	SAE O 7/16"
7714-04-08	ORFS 04	SAE O 1/2"
7714-04-09	ORFS 04	SAE O 9/16"
7714-04-12	ORFS 04	SAE O 3/4"
7714-06-07	ORFS 06	SAE O 7/16"
7714-06-08	ORFS 06	SAE O 1/2"
7714-06-09	ORFS 06	SAE O 9/16"
7714-06-12	ORFS 06	SAE O 3/4"
7714-06-14	ORFS 06	SAE O 7/8"
7714-06-17	ORFS 06	SAE O 1 1/16"
7714-06-21	ORFS 06	SAE O 1 5/16"
7714-08-09	ORFS 08	SAE O 9/16"
7714-08-12	ORFS 08	SAE O 3/4"
7714-08-14	ORFS 08	SAE O 7/8"
7714-08-17	ORFS 08	SAE O 1 1/16"
7714-08-21	ORFS 08	SAE O 1 5/16"
7714-10-12	ORFS 10	SAE O 3/4"
7714-10-14	ORFS 10	SAE O 7/8"
7714-10-17	ORFS 10	SAE O 1 1/16"
7714-10-21	ORFS 10	SAE O 1 5/16"
7714-12-09	ORFS 12	SAE O 9/16"
7714-12-12	ORFS 12	SAE O 3/4"
7714-12-14	ORFS 12	SAE O 7/8"
7714-12-17	ORFS 12	SAE O 1 1/16"
7714-12-21	ORFS 12	SAE O 1 5/16"
7714-16-12	ORFS 16	SAE O 3/4"
7714-16-14	ORFS 16	SAE O 7/8"
7714-16-17	ORFS 16	SAE O 1 1/16"
7714-16-21	ORFS 16	SAE O 1 5/16"
7714-16-26	ORFS 16	SAE O 1 5/8"
7714-20-21	ORFS 20	SAE O 1 5/16"
7714-20-26	ORFS 20	SAE O 1 5/8"
7714-20-30	ORFS 20	SAE O 1 7/8"
7714-24-30	ORFS 24	SAE O 1 7/8"

Part number	Thread 1	Thread 2
7716-04-04	ORFS 04	G 1/4"
7716-04-06	ORFS 04	G 3/8"
7716-04-08	ORFS 04	G 1/2"
7716-06-06	ORFS 06	G 3/8"
7716-06-08	ORFS 06	G 1/2"
7716-06-12	ORFS 06	G 3/4"
7716-08-04	ORFS 08	G 1/4"
7716-08-06	ORFS 08	G 3/8"
7716-08-08	ORFS 08	G 1/2"
7716-08-12	ORFS 08	G 3/4"
7716-10-08	ORFS 10	G 1/2"
7716-10-12	ORFS 10	G 3/4"
7716-10-16	ORFS 10	G 1"
7716-12-08	ORFS 12	G 1/2"
7716-12-12	ORFS 12	G 3/4"
7716-12-16	ORFS 12	G 1"
7716-12-20	ORFS 12	G 1 1/4"
7716-16-12	ORFS 16	G 3/4"
7716-16-16	ORFS 16	G 1"
7716-16-20	ORFS 16	G 1 1/4"
7716-20-16	ORFS 20	G 1"
7716-20-20	ORFS 20	G 1 1/4"
7716-20-24	ORFS 20	G 1 1/2"
7716-24-24	ORFS 24	G 1 1/2"

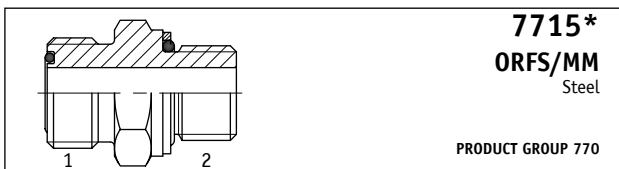

7715*
ORFS/MM
Steel

PRODUCT GROUP 770



7717
ORFS/JIC
Steel

PRODUCT GROUP 770

Part number	Thread 1	Thread 2
7715-04-10	ORFS 04	M 10 x 1,0
7715-04-12	ORFS 04	M 12 x 1,5
7715-04-14	ORFS 04	M 14 x 1,5
7715-04-16	ORFS 04	M 16 x 1,5
7715-06-12	ORFS 06	M 12 x 1,5
7715-06-14	ORFS 06	M 14 x 1,5
7715-06-16	ORFS 06	M 16 x 1,5
7715-08-14	ORFS 08	M 14 x 1,5
7715-08-16	ORFS 08	M 16 x 1,5
7715-08-18	ORFS 08	M 18 x 1,5
7715-10-14	ORFS 10	M 14 x 1,5
7715-10-18	ORFS 10	M 18 x 1,5
7715-10-22	ORFS 10	M 22 x 1,5
7715-12-18	ORFS 12	M 18 x 1,5
7015-12-27	ORFS 12	M 27 x 2,0
7715-12-33	ORFS 12	M 33 x 2,0
7715-16-27	ORFS 16	M 27 x 2,0
7715-20-42	ORFS 20	M 42 x 2,0

Part number	Thread 1	Thread 2
7717-06-09	ORFS 06	JIC 9/16"-18
7717-08-12	ORFS 08	JIC 3/4"-16
7717-10-14	ORFS 10	JIC 7/8"-14
7717-12-17	ORFS 12	JIC 1 1/16"-12
7717-16-21	ORFS 16	JIC 1 5/16"-12

* Available in a improved version with ED sealing, see 7718





7718
ORFS/MM – ED
Steel

PRODUCT GROUP 770

Part number	Thread 1	Thread 2
7718-04-10	ORFS 04	M 10 x 1,0
7718-04-12	ORFS 04	M 12 x 1,5
7718-04-14	ORFS 04	M 14 x 1,5
7718-04-16	ORFS 04	M 16 x 1,5
7718-06-12	ORFS 06	M 12 x 1,5
7718-06-14	ORFS 06	M 14 x 1,5
7718-06-16	ORFS 06	M 16 x 1,5
7718-08-14	ORFS 08	M 14 x 1,5
7718-08-16	ORFS 08	M 16 x 1,5
7718-08-18	ORFS 08	M 18 x 1,5
7718-10-14	ORFS 10	M 14 x 1,5
7718-10-18	ORFS 10	M 18 x 1,5
7718-10-22	ORFS 10	M 22 x 1,5
7718-12-18	ORFS 12	M 18 x 1,5
7718-12-27	ORFS 12	M 27 x 2,0
7718-12-33	ORFS 12	M 33 x 2,0
7718-16-27	ORFS 16	M 27 x 2,0
7718-20-42	ORFS 20	M 42 x 2,0



7722
ORFS/BSP 90°
Steel

PRODUCT GROUP 770

Part number	Thread 1	Type	Thread 2
7722-04-02	ORFS 04	90°	G 1/8"
7722-04-04	ORFS 04	90°	G 1/4"
7722-04-06	ORFS 04	90°	G 3/8"
7722-06-04	ORFS 06	90°	G 1/4"
7722-06-06	ORFS 06	90°	G 3/8"
7722-06-08	ORFS 06	90°	G 1/2"
7722-08-04	ORFS 08	90°	G 1/4"
7722-08-06	ORFS 08	90°	G 3/8"
7722-08-08	ORFS 08	90°	G 1/2"
7722-08-12	ORFS 08	90°	G 3/4"
7722-10-06	ORFS 10	90°	G 3/8"
7722-10-08	ORFS 10	90°	G 1/2"
7722-10-12	ORFS 10	90°	G 3/4"
7722-12-08	ORFS 12	90°	G 1/2"
7722-12-12	ORFS 12	90°	G 3/4"
7722-12-16	ORFS 12	90°	G 1"
7722-16-12	ORFS 16	90°	G 3/4"
7722-16-16	ORFS 16	90°	G 1"
7722-20-16	ORFS 20	90°	G 1"
7722-20-20	ORFS 20	90°	G 1 1/4"
7722-20-24	ORFS 20	90°	G 1 1/2"
7722-24-24	ORFS 24	90°	G 1 1/2"

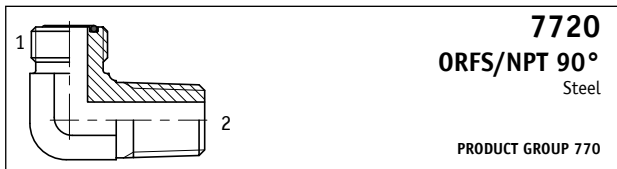

7720
ORFS/NPT 90°
Steel

PRODUCT GROUP 770

Part number	Thread 1	Thread 2
7720-04-02	ORFS 04	NPT 1/8" - 27 NPT
7720-04-04	ORFS 04	NPT 1/4" - 18 NPT
7720-06-02	ORFS 06	NPT 1/8" - 27 NPT
7720-06-04	ORFS 06	NPT 1/4" - 18 NPT
7720-06-06	ORFS 06	NPT 3/8" - 18 NPT
7720-06-08	ORFS 06	NPT 1/2" - 14 NPT
7720-08-06	ORFS 08	NPT 3/8" - 18 NPT
7720-08-08	ORFS 08	NPT 1/2" - 14 NPT
7720-08-12	ORFS 08	NPT 3/4" - 14 NPT
7720-10-08	ORFS 10	NPT 1/2" - 14 NPT
7720-10-12	ORFS 10	NPT 3/4" - 14 NPT
7720-12-08	ORFS 12	NPT 1/2" - 14 NPT
7720-12-12	ORFS 12	NPT 3/4" - 14 NPT
7720-12-16	ORFS 12	NPT 1" - 11½ NPT
7720-16-16	ORFS 16	NPT 1" - 11½ NPT
7720-20-20	ORFS 20	NPT 1 1/4" - 11½ NPT



7723
ORFS/SAE 90°
Steel

PRODUCT GROUP 770

Part number	Thread 1	Type	Thread 2
7723-04-07	ORFS 04	90°	SAE O 7/16"
7723-04-09	ORFS 04	90°	SAE O 9/16"
7723-04-12	ORFS 04	90°	SAE O 3/4"
7723-06-07	ORFS 06	90°	SAE O 7/16"
7723-06-09	ORFS 06	90°	SAE O 9/16"
7723-06-12	ORFS 06	90°	SAE O 3/4"
7723-06-14	ORFS 06	90°	SAE O 7/8"
7723-06-17	ORFS 06	90°	SAE O 1 1/16"
7723-08-09	ORFS 08	90°	SAE O 9/16"
7723-08-12	ORFS 08	90°	SAE O 3/4"
7723-08-14	ORFS 08	90°	SAE O 7/8"
7723-08-17	ORFS 08	90°	SAE O 1 1/16"
7723-10-12	ORFS 10	90°	SAE O 3/4"
7723-10-14	ORFS 10	90°	SAE O 7/8"
7723-10-17	ORFS 10	90°	SAE O 1 1/16"
7723-12-12	ORFS 12	90°	SAE O 3/4"
7723-12-14	ORFS 12	90°	SAE O 7/8"
7723-12-17	ORFS 12	90°	SAE O 1 1/16"
7723-12-21	ORFS 12	90°	SAE O 1 5/16"
7723-16-17	ORFS 16	90°	SAE O 1 1/16"
7723-16-19	ORFS 16	90°	SAE O 1 3/16"
7723-16-21	ORFS 16	90°	SAE O 1 5/16"
7723-16-26	ORFS 16	90°	SAE O 1 5/8"
7723-20-21	ORFS 20	90°	SAE O 1 5/16"
7723-20-26	ORFS 20	90°	SAE O 1 5/8"
7723-24-30	ORFS 24	90°	SAE O 1 7/8"

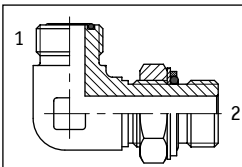

7724
ORFS/MM 90°
Steel

PRODUCT GROUP 770

Part number	Thread 1	Type	Thread 2
7724-04-10	ORFS 04	90°	M 10 x 1,5
7724-04-12	ORFS 04	90°	M 12 x 1,5
7724-04-14	ORFS 04	90°	M 14 x 1,5
7724-06-12	ORFS 06	90°	M 12 x 1,5
7724-06-14	ORFS 06	90°	M 14 x 1,5
7724-06-16	ORFS 06	90°	M 16 x 1,5
7724-08-14	ORFS 08	90°	M 14 x 1,5
7724-08-16	ORFS 08	90°	M 16 x 1,5
7724-08-18	ORFS 08	90°	M 18 x 1,5
7724-10-18	ORFS 10	90°	M 18 x 1,5
7724-10-22	ORFS 10	90°	M 22 x 1,5
7724-10-27	ORFS 10	90°	M 27 x 2,0
7724-12-22	ORFS 12	90°	M 22 x 1,5
7724-12-27	ORFS 12	90°	M 27 x 2,0
7724-12-33	ORFS 12	90°	M 33 x 2,0
7724-16-33	ORFS 16	90°	M 33 x 2,0
7724-20-42	ORFS 20	90°	M 42 x 2,0

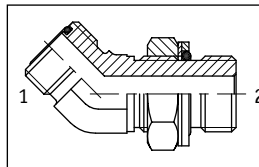

7732
ORFS/BSP 45°
Steel

PRODUCT GROUP 770

Part number	Thread 1	Type	Thread 2
7732-04-02	ORFS 04	45°	G 1/8"
7732-04-04	ORFS 04	45°	G 1/4"
7732-06-04	ORFS 06	45°	G 1/4"
7732-06-06	ORFS 06	45°	G 3/8"
7732-06-08	ORFS 06	45°	G 1/2"
7732-08-06	ORFS 08	45°	G 3/8"
7732-08-08	ORFS 08	45°	G 1/2"
7732-08-12	ORFS 08	45°	G 3/4"
7732-10-08	ORFS 10	45°	G 1/2"
7732-12-08	ORFS 12	45°	G 1/2"
7732-12-12	ORFS 12	45°	G 3/4"
7732-12-16	ORFS 12	45°	G 1"
7732-16-16	ORFS 16	45°	G 1"
7732-16-20	ORFS 16	45°	G 1 1/4"
7732-20-20	ORFS 20	45°	G 1 1/4"
7732-24-24	ORFS 24	45°	G 1 1/2"

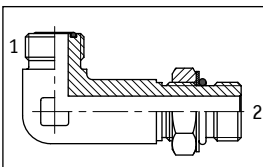

7725
ORFS/UNF 90° lång
Steel

PRODUCT GROUP 770

Part number	Thread 1	Type	Thread 2
7725-04-07	ORFS 04	90° SAE O	7/16" - 20
7725-06-09	ORFS 06	90° SAE O	9/16" - 18
7725-08-12	ORFS 08	90° SAE O	3/4" - 16
7724-10-14	ORFS 10	90° SAE O	7/8" - 14
7725-12-17	ORFS 12	90° SAE O	1 1/16" - 12
7725-16-21	ORFS 16	90° SAE O	1 5/16" - 12
7725-20-26	ORFS 20	90° SAE O	1 5/8" - 12

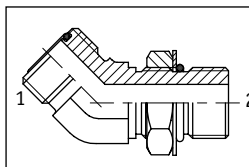

7733
ORFS/UNF 45°
Steel

PRODUCT GROUP 770

Part number	Thread 1	Type	Thread 2
7733-04-07	ORFS 04	45°	SAE O 7/16"
7733-04-09	ORFS 04	45°	SAE O 9/16"
7733-04-12	ORFS 04	45°	SAE O 3/4"
7733-06-07	ORFS 06	45°	SAE O 7/16"
7733-06-09	ORFS 06	45°	SAE O 9/16"
7733-06-12	ORFS 06	45°	SAE O 3/4"
7733-08-08	ORFS 08	45°	SAE O 1/2"
7733-08-09	ORFS 08	45°	SAE O 9/16"
7733-08-12	ORFS 08	45°	SAE O 3/4"
7733-08-14	ORFS 08	45°	SAE O 7/8"
7733-10-12	ORFS 10	45°	SAE O 3/4"
7733-10-14	ORFS 10	45°	SAE O 7/8"
7733-10-17	ORFS 10	45°	SAE O 1 1/16"
7733-12-14	ORFS 12	45°	SAE O 7/8"
7733-12-17	ORFS 12	45°	SAE O 1 1/16"
7733-16-21	ORFS 16	45°	SAE O 1 5/16"
7733-16-17	ORFS 16	45°	SAE O 1 1/16"
7733-16-26	ORFS 16	45°	SAE O 1 5/8"
7733-20-21	ORFS 20	45°	SAE O 1 5/16"
7733-20-26	ORFS 20	45°	SAE O 1 5/8"

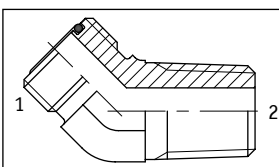

7730
ORFS/NPT 45°
Steel

PRODUCT GROUP 770

Part number	Thread 1	Type	Thread 2
7730-04-02	ORFS 04	45°	1/8" - 27 NPT
7730-04-04	ORFS 04	45°	1/4" - 18 NPT
7730-04-06	ORFS 04	45°	3/8" - 18 NPT
7730-06-04	ORFS 06	45°	1/4" - 18 NPT
7730-06-06	ORFS 06	45°	3/8" - 18 NPT
7730-06-08	ORFS 06	45°	1/2" - 14 NPT
7730-10-08	ORFS 10	45°	1/2" - 14 NPT
7730-12-12	ORFS 12	45°	3/4" - 14 NPT
7730-16-16	ORFS 16	45°	1" - 11 1/2 NPT
7730-24-24	ORFS 24	45°	1 1/2" - 11 1/2 NPT

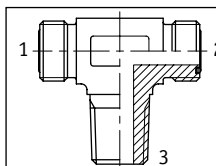

7740
ORFS/NPT T
Steel

PRODUCT GROUP 770

Part number	Thread 1	Thread 2	Thread 3
7740-04-02	ORFS 04	ORFS 04	1/8" - 27 NPT
7740-04-04	ORFS 04	ORFS 04	1/4" - 18 NPT
7740-06-04	ORFS 06	ORFS 06	1/4" - 18 NPT
7740-06-06	ORFS 06	ORFS 06	3/8" - 18 NPT
7740-08-06	ORFS 08	ORFS 08	3/8" - 18 NPT
7740-12-12	ORFS 12	ORFS 12	3/4" - 14 NPT
7740-16-16	ORFS 16	ORFS 16	1" - 11 1/2 NPT



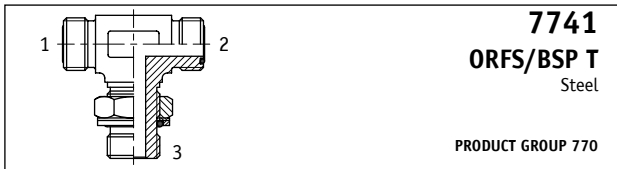

7741
ORFS/BSP T
Steel

PRODUCT GROUP 770

Part number	Thread 1	Thread 2	Thread 3
7741-04-04	ORFS 04	ORFS 04	G 1/4"
7741-06-04	ORFS 06	ORFS 06	G 1/4"
7741-06-06	ORFS 06	ORFS 06	G 3/8"
7741-08-08	ORFS 08	ORFS 08	G 1/2"
7741-10-12	ORFS 10	ORFS 10	G 3/4"
7741-12-12	ORFS 12	ORFS 12	G 3/4"
7741-16-16	ORFS 16	ORFS 16	G 1"

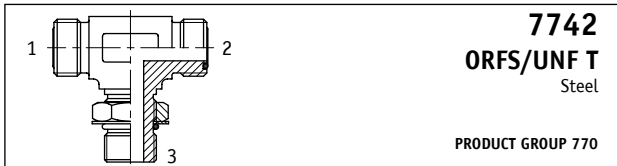

7742
ORFS/UNF T
Steel

PRODUCT GROUP 770

Part number	Thread 1	Thread 2	Thread 3
7742-04-07	ORFS 04	ORFS 04	SAE O 7/16"
7742-06-09	ORFS 06	ORFS 06	SAE O 9/16"
7742-06-12	ORFS 06	ORFS 06	SAE O 3/4"
7742-08-12	ORFS 08	ORFS 08	SAE O 3/4"
7742-10-14	ORFS 10	ORFS 10	SAE O 7/8"
7742-12-14	ORFS 12	ORFS 12	SAE O 7/8"
7742-12-17	ORFS 12	ORFS 12	SAE O 1 1/16"
7742-12-21	ORFS 12	ORFS 12	SAE O 1 5/16"
7742-16-21	ORFS 16	ORFS 16	SAE O 1 5/16"

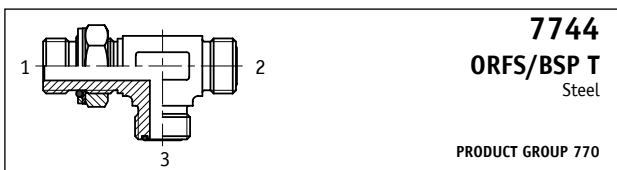

7744
ORFS/BSP T
Steel

PRODUCT GROUP 770

Part number	Thread 1	Thread 2	Thread 3
7744-04-04	G 1/4"	ORFS 04	ORFS 04
7744-06-06	G 3/8"	ORFS 06	ORFS 06
7744-08-06	G 3/8"	ORFS 08	ORFS 08
7744-08-08	G 1/2"	ORFS 08	ORFS 08
7744-10-08	G 1/2"	ORFS 10	ORFS 10
7744-12-12	G 3/4"	ORFS 12	ORFS 12
7744-16-16	G 1"	ORFS 16	ORFS 16

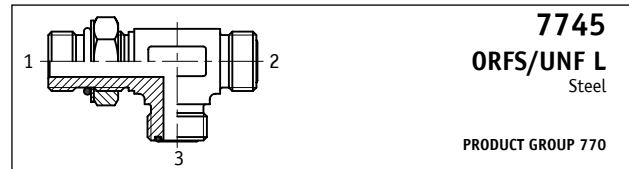

7745
ORFS/UNF L
Steel

PRODUCT GROUP 770

Part number	Thread 1	Thread 2	Thread 3
7745-04-07	SAE O 7/16"	ORFS 04	ORFS 04
7745-04-09	SAE O 9/16"	ORFS 04	ORFS 04
7745-06-07	SAE O 7/16"	ORFS 06	ORFS 06
7745-06-09	SAE O 9/16"	ORFS 06	ORFS 06
7745-06-12	SAE O 3/4"	ORFS 06	ORFS 06
7745-08-09	SAE O 9/16"	ORFS 08	ORFS 08
7745-08-12	SAE O 3/4"	ORFS 08	ORFS 08
7745-08-17	SAE O 1 1/16"	ORFS 08	ORFS 08
7745-10-14	SAE O 7/8"	ORFS 10	ORFS 10
7745-10-17	SAE O 1 1/16"	ORFS 10	ORFS 10
7745-12-12	SAE O 3/4"	ORFS 12	ORFS 12
7745-12-17	SAE O 1 1/16"	ORFS 12	ORFS 12
7745-16-21	SAE O 1 5/16 M	ORFS 16	ORFS 16



7758
ORFS/ORFS
Steel

PRODUCT GROUP 770

Part number	Thread 1	Thread 2
7758-04-04	ORFS 04	ORFS 04
7758-06-06	ORFS 06	ORFS 06
7758-08-08	ORFS 08	ORFS 08
7758-12-16	ORFS 12	ORFS 16

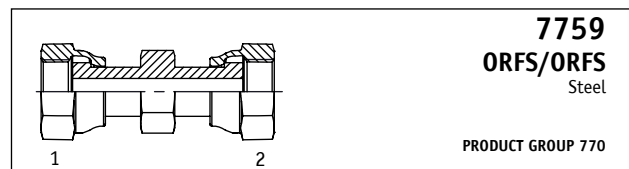

7759
ORFS/ORFS
Steel

PRODUCT GROUP 770

Part number	Thread 1	Thread 2
7759-04-04	ORFS 04	ORFS 04
7759-06-06	ORFS 06	ORFS 06
7759-08-08	ORFS 08	ORFS 08
7759-10-10	ORFS 10	ORFS 10

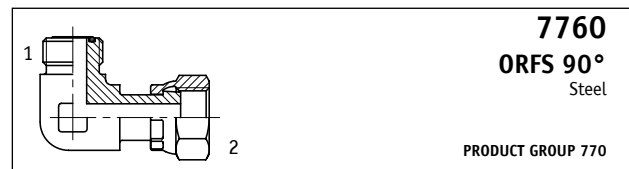

7760
ORFS 90°
Steel

PRODUCT GROUP 770

Part number	Thread 1	Type	Thread 2
7760-04-04	ORFS 04	90°	ORFS 04
7760-06-06	ORFS 06	90°	ORFS 06
7760-08-08	ORFS 08	90°	ORFS 08
7760-10-10	ORFS 10	90°	ORFS 10
7760-12-12	ORFS 12	90°	ORFS 12
7760-16-16	ORFS 16	90°	ORFS 16
7760-20-20	ORFS 20	90°	ORFS 20
7760-24-24	ORFS 24	90°	ORFS 24

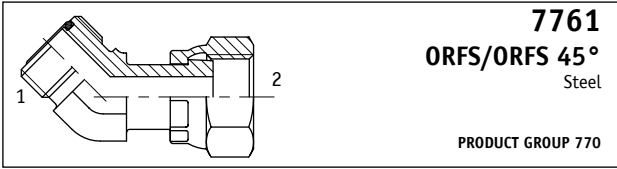

7761
ORFS/ORFS 45°
Steel

PRODUCT GROUP 770

Part number	Thread 1	Type	Thread 2
7761-04-04	ORFS 04	45°	ORFS 04
7761-06-06	ORFS 06	45°	ORFS 06
7761-08-08	ORFS 08	45°	ORFS 08
7761-10-10	ORFS 10	45°	ORFS 10
7761-12-12	ORFS 12	45°	ORFS 12
7761-16-16	ORFS 16	45°	ORFS 16
7761-20-20	ORFS 20	45°	ORFS 20
7761-24-24	ORFS 24	45°	ORFS 24

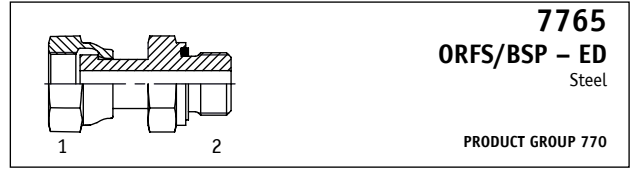

7765
ORFS/BSP - ED
Steel

PRODUCT GROUP 770

Part number	Thread 1	Thread 2
7765-04-04	ORFS 04	G 1/4"
7765-04-06	ORFS 04	G 3/8"
7765-06-04	ORFS 06	G 1/4"
7765-06-06	ORFS 06	G 3/8"
7765-08-06	ORFS 08	G 3/8"
7765-08-08	ORFS 08	G 1/2"
7765-10-08	ORFS 10	G 1/2"
7765-12-08	ORFS 12	G 1/2"
7765-12-12	ORFS 12	G 3/4"
7765-16-16	ORFS 16	G 1"
7765-20-20	ORFS 20	G 1 1/4"
7765-24-24	ORFS 24	G 1 1/2"

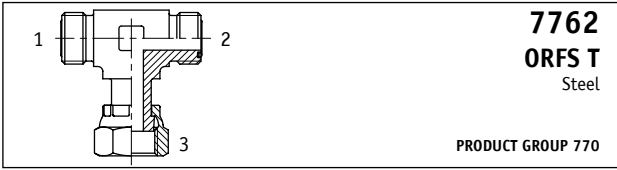

7762
ORFS T
Steel

PRODUCT GROUP 770

Part number	Thread 1	Thread 2	Thread 3
7762-04-04	ORFS 04	ORFS 04	ORFS 04
7762-06-06	ORFS 06	ORFS 06	ORFS 06
7762-08-08	ORFS 08	ORFS 08	ORFS 08
7762-10-10	ORFS 10	ORFS 10	ORFS 10
7762-12-12	ORFS 12	ORFS 12	ORFS 12
7762-16-16	ORFS 16	ORFS 16	ORFS 16
7762-20-20	ORFS 20	ORFS 20	ORFS 20
7762-24-24	ORFS 24	ORFS 24	ORFS 24

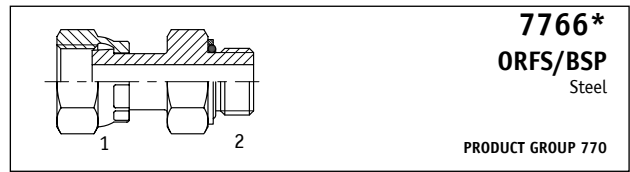

7766*
ORFS/BSP
Steel

PRODUCT GROUP 770

Part number	Thread 1	Thread 2
7766-04-04	ORFS 04	G 1/4"
7766-04-06	ORFS 04	G 3/8"
7766-06-04	ORFS 06	G 1/4"
7766-06-06	ORFS 06	G 3/8"
7766-08-06	ORFS 08	G 3/8"
7766-08-08	ORFS 08	G 1/2"
7766-10-08	ORFS 10	G 1/2"
7766-12-08	ORFS 12	G 1/2"
7766-12-12	ORFS 12	G 3/4"
7766-16-16	ORFS 16	G 1"
7766-20-20	ORFS 20	G 1 1/4"
7766-24-24	ORFS 24	G 1 1/2"

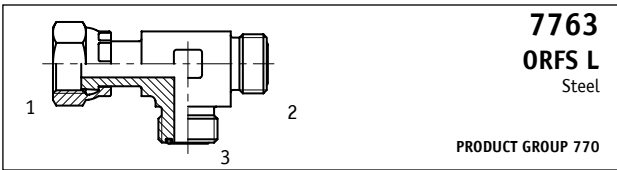

7763
ORFS L
Steel

PRODUCT GROUP 770

Part number	Thread 1	Thread 2	Thread 3
7763-04-04	ORFS 04	ORFS 04	ORFS 04
7763-06-06	ORFS 06	ORFS 06	ORFS 06
7763-08-08	ORFS 08	ORFS 08	ORFS 08
7763-10-06	ORFS 10	ORFS 10	ORFS 06
7763-10-10	ORFS 10	ORFS 10	ORFS 10
7763-12-12	ORFS 12	ORFS 12	ORFS 12
7763-16-16	ORFS 16	ORFS 16	ORFS 16
7763-20-20	ORFS 20	ORFS 20	ORFS 20
7763-24-24	ORFS 24	ORFS 24	ORFS 24

*Available in a improved version with ED sealing, see 7765

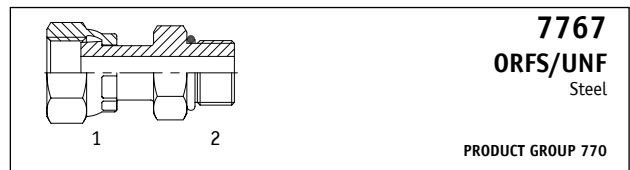

7767
ORFS/UNF
Steel

PRODUCT GROUP 770

Part number	Thread 1	Thread 2
7767-04-09	ORFS 04	SAE O 9/16"
7767-06-09	ORFS 06	SAE O 9/16"
7767-08-09	ORFS 08	SAE O 9/16"
7767-08-12	ORFS 08	SAE O 3/4"
7767-12-17	ORFS 12	SAE O 1 1/16"



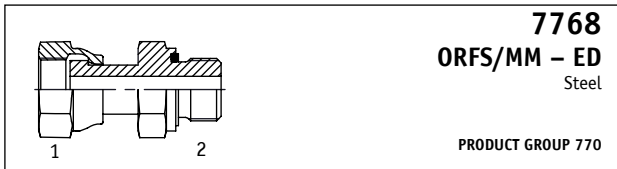

7768
ORFS/MM – ED
Steel

PRODUCT GROUP 770

Part number	Thread 1	Thread 2
7768-04-12	ORFS 04	M12 x 1,5
7768-06-12	ORFS 06	M12 x 1,5
7768-06-16	ORFS 06	M16 x 1,5
7768-08-18	ORFS 08	M18 x 1,5
7768-10-22	ORFS 10	M22 x 1,5
7768-12-27	ORFS 12	M27 x 2
7768-16-33	ORFS 16	M33 x 2
7768-20-42	ORFS 20	M42 x 2
7768-24-48	ORFS 24	M48 x 2

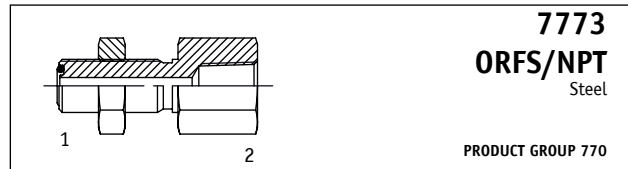

7773
ORFS/NPT
Steel

PRODUCT GROUP 770

Part number	Thread 1	Thread 2
7773-08-06	ORFS 08	3/8"-18 NPT
7773-10-08	ORFS 10	1/2"-14 NPT
7773-12-12	ORFS 12	3/4"-14 NPT



7770
ORFS Reduction
Steel

PRODUCT GROUP 770

Part number	Thread 1	Type	Thread 2
7770-04-06	ORFS 04	Reduction	ORFS 06
7770-06-04	ORFS 06	Reduction	ORFS 04
7770-08-04	ORFS 08	Reduction	ORFS 04
7770-08-06	ORFS 08	Reduction	ORFS 06
7770-10-04	ORFS 10	Reduction	ORFS 04
7770-10-06	ORFS 10	Reduction	ORFS 06
7770-10-08	ORFS 10	Reduction	ORFS 08
7770-12-04	ORFS 12	Reduction	ORFS 04
7770-12-06	ORFS 12	Reduction	ORFS 06
7770-12-08	ORFS 12	Reduction	ORFS 08
7770-12-10	ORFS 12	Reduction	ORFS 10
7770-16-04	ORFS 16	Reduction	ORFS 04
7770-16-06	ORFS 16	Reduction	ORFS 06
7770-16-08	ORFS 16	Reduction	ORFS 08
7770-16-10	ORFS 16	Reduction	ORFS 10
7770-16-12	ORFS 16	Reduction	ORFS 12
7770-20-12	ORFS 20	Reduction	ORFS 12
7770-20-16	ORFS 20	Reduction	ORFS 16
7770-24-20	ORFS 24	Reduction	ORFS 20



7780
ORFS/BSP
Steel

PRODUCT GROUP 770

Part number	Thread 1	Thread 2
7780-04-04	ORFS 04	G 1/4"

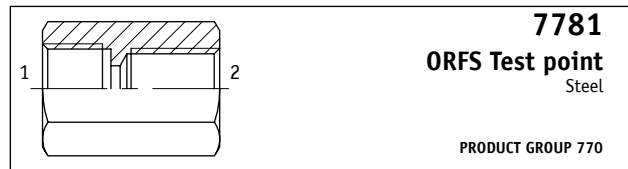

7781
ORFS Test point
Steel

PRODUCT GROUP 770

Part number	Thread 1	Type	Thread 2
7781-04-04	ORFS 04	Test point	G 1/4"
7781-06-04	ORFS 06	Test point	G 1/4"
7781-08-04	ORFS 08	Test point	G 1/4"
7781-08-06	ORFS 08	Test point	G 3/8"
7781-12-04	ORFS 12	Test point	G 1/4"
7781-16-04	ORFS 16	Test point	G 1/4"
7781-20-04	ORFS 20	Test point	G 1/4"

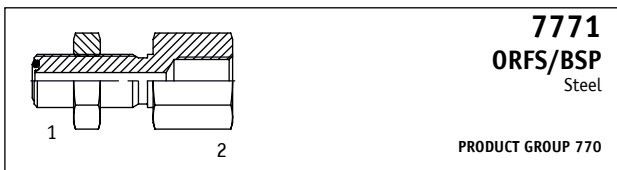

7771
ORFS/BSP
Steel

PRODUCT GROUP 770

Part number	Thread 1	Thread 2
7771-04-04	ORFS 04	G 1/4"
7771-16-16	ORFS 16	G 1"

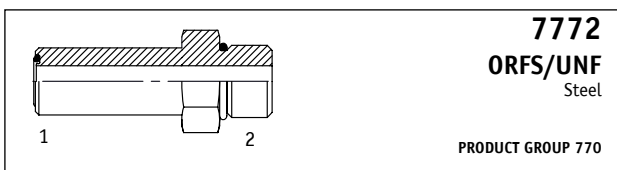

7772
ORFS/UNF
Steel

PRODUCT GROUP 770

Part number	Thread 1	Thread 2
7772-08-14	ORFS 08	SAE O 7/8"



7790
ORFS Cap
Steel

PRODUCT GROUP 770

Part number	Type	Thread
7790-00-04	Cap	ORFS 04
7790-00-06	Cap	ORFS 06
7790-00-08	Cap	ORFS 08
7790-00-10	Cap	ORFS 10
7790-00-12	Cap	ORFS 12
7790-00-16	Cap	ORFS 16
7790-00-20	Cap	ORFS 20
7790-00-24	Cap	ORFS 24



7791
ORFS plug
Steel

PRODUCT GROUP 770

Part number	Type	Thread
7791-00-04	Plug	ORFS 04
7791-00-06	Plug	ORFS 06
7791-00-08	Plug	ORFS 08
7791-00-10	Plug	ORFS 10
7791-00-12	Plug	ORFS 12
7791-00-16	Plug	ORFS 16
7791-00-20	Plug	ORFS 20
7791-00-24	Plug	ORFS 24



5610-07
ORFS O-ring

PRODUCT GROUP 510

Part number	Size	Dimension
5610-07-04	ORFS 04	7,65 x 1,78
5610-07-06	ORFS 06	9,25 x 1,78
5610-07-08	ORFS 08	12,42 x 1,78
5610-07-10	ORFS 10	15,60 x 1,78
5610-07-12	ORFS 12	18,77 x 1,78
5610-07-16	ORFS 16	23,52 x 1,78
5610-07-20	ORFS 20	29,87 x 1,78
5610-07-24	ORFS 24	37,82 x 1,78



7792
ORFS nut
Steel

PRODUCT GROUP 770

Part number	Thread 1	Pipe dim.
7792-00-04	ORFS 04	6 mm
7792-00-06	ORFS 06	8 10 mm
7792-00-08	ORFS 08	12 mm
7792-00-10	ORFS 10	14 15 16 mm
7792-00-12	ORFS 12	18 20 mm
7792-00-16	ORFS 16	22 25 mm
7792-00-20	ORFS 20	28 30 32 mm
7792-00-24	ORFS 24	35 38 mm



7794
Braze sleeve

PRODUCT GROUP 770

Part number	Type	Dimension
7794-00-10	Braze sleeve	10 mm
7794-00-12	Braze sleeve	12 mm
7794-00-16	Braze sleeve	16 mm
7794-00-20	Braze sleeve	20 mm
7794-00-25	Braze sleeve	25 mm
7794-00-30	Braze sleeve	30 mm
7794-00-32	Braze sleeve	32 mm



7793
Clamping sleeve

PRODUCT GROUP 770

Part number	Type	Pipe dim.
7793-00-06	Clamping sleeve	6 mm
7793-00-08	Clamping sleeve	8 mm
7793-00-10	Clamping sleeve	10 mm
7793-00-12	Clamping sleeve	12 mm
7793-00-14	Clamping sleeve	14 mm
7793-00-15	Clamping sleeve	15 mm
7793-00-16	Clamping sleeve	16 mm
7793-00-18	Clamping sleeve	18 mm
7793-00-20	Clamping sleeve	20 mm
7793-00-22	Clamping sleeve	22 mm
7793-00-25	Clamping sleeve	25 mm
7793-00-28	Clamping sleeve	28 mm
7793-00-30	Clamping sleeve	30 mm
7793-00-32	Clamping sleeve	32 mm
7793-00-35	Clamping sleeve	35 mm
7793-00-38	Clamping sleeve	38 mm

